

领冠电源 调光专家 随“芯”所调 客户至上



0-10V Dimmable LKAD013D-C



—产品特性/Feature—

- 200-240VAC (50/60Hz) 输入 / 200-240VAC (50/60Hz) Input
- 隔离方案, 0-10V调光, 无频闪 / Isolated, 0-10V dimming, no flicker
- 高效率、高功率因素, 稳定性好 / High efficiency, high PF, good steady;
- 短路保护, 过流保护, 过压保护 / short circuit/over load/over current/;

调光流畅, 兼容性好 / smooth dimming, good compatibility

- 自然风冷 / cooling by free air convection;
- 100%满载老化测试 / 100% full load burn-in test;
- 独立外置, Class II 恒流类型 / independent, Class II constant current type;
- 防护等级 IP20 / degree of protection IP20;
- 适用于面板灯/天花灯/筒灯等照明应用 / suitable for LED lighting, ceiling light, down light and panel light;
- 3年质保期 / 3 years warranty.



产品参数/Specification

Model	LKAD013D-C	
输入 Input	AC电压范围/AC Voltage range	200-240Vac
	频率/Frequency	50hz
	谐波/THD	
	功率因数/Power factor	0.993
输出 Output	额定电压/Rated voltage	40V
	空载电压/No-load Voltage	45V
	DC电压范围/DC voltage range	26-40V
	DC电流范围/DC current range	300mA
	电流精度/Current precision	(+/-) 5%
	额定功率/Rated power	12W
	输入纹波/Output ripple	<200mV
	开机延时/Setup Time	≤0.5s/230VAC
使用环境 Environment Requirements	工作温度/湿度要求 Operating Temp./RH	-30~+45°C/20~95%
	储存温度, 湿度要求 Storage Temp./RH	-40~+80°C/10~95%
安全和电磁兼容	认证编号/Certificate	IEC61347-2-13 EN6147-2-13
		EN55015
其他	尺寸/Size	
	重量/Net weight	

测试数据/Test data

输入电压 Input voltage (Vac)	输入电流 Input current (mA)	输入功率 Input power (W)	功率因数 PF	输出电压 Output voltage (Vdc)	输出电流 Output current (mA)	输出功率 Output Power (W)	转换效率 Efficiency (%)
100	76.1700	7.750	0.9360	20.00	293	5.86	76%
	111.2000	10.770	0.9930	30.00	291	8.73	81%
	143.1000	14.290	0.9970	40.00	289	11.56	81%
240	36.4500	7.620	0.8790	20.00	289	5.78	76%
	48.4000	10.890	0.9240	30.00	289	8.67	80%
	60.9200	13.900	0.9490	40.00	288	11.52	83%
277	34.3000	7.740	0.8400	20.00	288	5.76	74%
	45.0700	10.860	0.9010	30.00	287	8.61	79%
	55.5600	13.870	0.9290	40.00	286	11.44	82%

调光测试数据Dimming test data

输入电压 Input voltage (Vac)	输入功率 Input power (W)	功率因数 PF	输出电压 Output voltage (Vdc)	输出电流 Output current (mA)	输出功率 Output Power (W)	调光电压 Dimming voltage (V)
230	0.97	0.383	36.00	0.00	0.00	0
230	1.59	0.513	36.00	10.00	0.36	1
230	3.01	0.632	36.00	49.00	1.76	2
230	4.43	0.720	36.00	85.00	3.06	3
230	5.96	0.795	36.00	124.00	4.46	4
230	7.66	0.839	36.00	166.00	5.98	5
230	9.21	0.870	36.00	204.00	7.34	6
230	10.80	0.898	36.00	242.00	8.71	7
230	12.40	0.916	36.00	281.00	10.12	8
230	13.93	0.929	36.00	318.00	11.45	9
230	14.65	0.934	36.00	336.00	12.10	10

调光曲线图

调光比

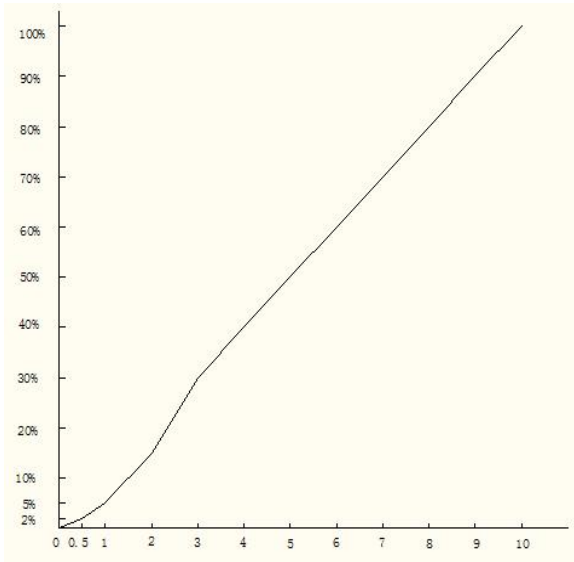

产品尺寸图/ Product Size Diagram

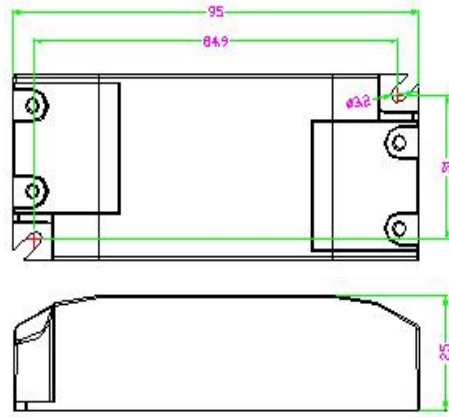
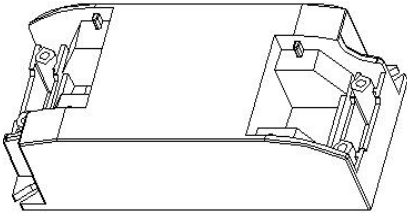

产品接线示意图/ Product Connection Diagram

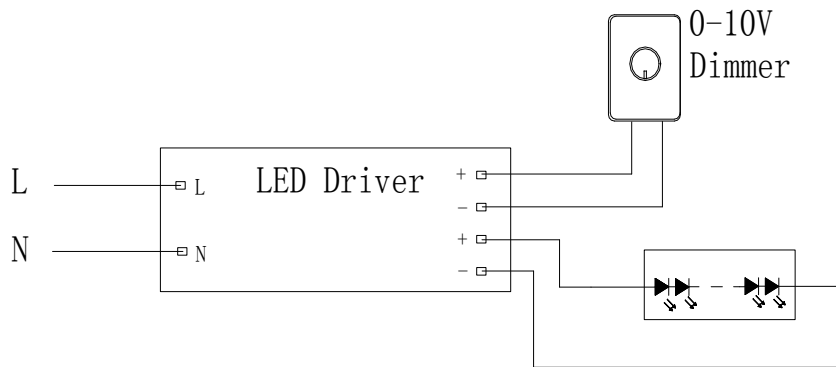

DIMMER为0-10V输入，蓝色线接调光正极，绿色线接调光负极。
红色线接负载正极，黑色线接负载负极。

备注/Note:

- 所有没提及到的参数都是在230V输入，额定负载和在周围温度为25°C的情况下测试的；
All parameters NOT specially mentioned are measured at 230VAC input, rated load and 25 of ambient temperature;
- 本驱动电源是作为一个部件与最终的设备结合进行操作的。因为EMC的性能在电源完全安装后会受到影响，因此最终设备制造商在完成安装后必须重新获取EMC指示认定。
The LED driver is considered as a component that will be operated in combination with final equipment. Since EMC performance will be affected by the complete installation, the final equipment manufacturers must re-qualify EMC Directive on the complete installation again.
- 可以直接与LEDs连接，但不适宜与额外的驱动电源使用；
Direct connecting to LEDs is suggested, but is not suitable for using additional drivers.
- 为了满足在灯具安装中最后的ErP校准要求，本驱动电源只能在一个不是永久地连接在交流干线的开关后面使用。
To fulfill requirements of the latest ErP regulation for lighting fixtures, this LED power supply can only be used behind a switch without permanently connect to the mains.

广东领冠智能科技有限公司
Guangdong Linkuan Smart Tech

地址：广东省东莞市万江区大莲塘工业区3号
Address: NO.3 Building, Daliantang Industrial Park,
Wanjiang District, Dongguan, Guangdong, China
Tel:+86-769-23129651 Fax:+86-23129652